



Eccentric Diaphragm Pumps for Gas / Air SP 600 EC / 620 EC / 625 EC



SP 600 EC
SP 620 EC



SP 625 EC-LC



SP 600 EC-LC
SP 620 EC-LC

Product Features

- diaphragm mini pump for air and gas
- single stage vacuum and pressure pump
- electric motor driven, oil free
- available in 6 / 12 / 24 volt dc
- minimal current consumption
- oil free / maintenance free
- reduced vibrations
- low noise
- virtually leak tight
- lightweight
- extremely small pocket size

Applications

- Stationary gas analyzers / gas monitors
- Anaesthesia monitoring
- Gas detectors
- Exhaust gas analysers
- Autosamplers
- Pipetting devices
- Blood pressure monitoring
- Dental vacuum pump
- Industrial pressure and vacuum applications
- Random access analyzers





The pumps listed below represent a typical selection of our wide range of eccentric pumps and are intended for initial tests. Customised versions for your individual application would be made without extra costs - please contact us!

Designation	SP 600 EC-LC		SP 600 EC	
Operating Voltage	12 Vdc	24 Vdc	12 Vdc	24 Vdc
Art.-No.	7s52100	7s52101	7s52115	7s52116
Pneumatic Performance				
Free Flow [l/min]	2,8	2,8	3,0	3,0
flow at: Pressure Side				
100 mbar [l/min]	2,3	2,3	2,4	2,4
max. Pressure [mbar]	1350	1350	1300	1300
flow at: Vacuum Side				
-100 mbar [l/min]	2,1	2,1	2,1	2,1
max. Vacuum [mbar]	-560	-560	-550	-550
Motor / Power Consumption				
Motor Type	Iron Core DC		Iron Core DC with Electromagnetic Suppression	
standard				
optional		-		-
max. Current [mA]	290	170	260	140
Construction				
Pump Head	PPS customer specific - upon request			
standard				
optional				
Diaphragm, Valves	EPDM FKM / FFKM / PTFE			
standard				
optional				
Weight [g]	165		184	

Performance Curves

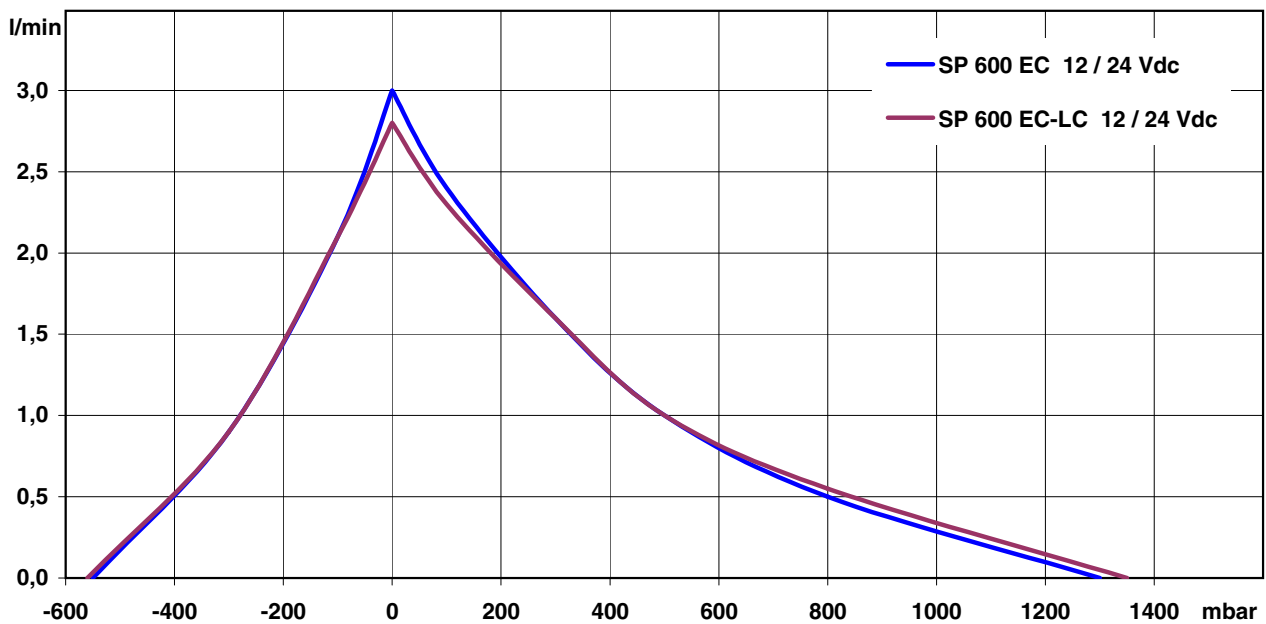



The pumps listed below represent a typical selection of our wide range of eccentric pumps and are intended for initial tests. Customised versions for your individual application would be made without extra costs - please contact us!

Designation	SP 620 EC-LC-DV		SP 620 EC-LC-VD	
Operating Voltage	12 Vdc	24 Vdc	12 Vdc	24 Vdc
Art.No.	7s57004	7s57005	7s57223	7s57224
Pneumatic Performance				
Free Flow [l/min]	4,5	4,5	4,5	4,5
flow at:	Pressure Side			
100 mbar [l/min]	3,5	3,5	-	-
max. Pressure [mbar]	1700	1700	-	-
flow at:	Vacuum Side			
-100 mbar [l/min]	3,4	3,4	3,4	3,4
max. Vacuum [mbar]	-650	-650	-700	-700
	Higher performances on request			
Motor / Power Consumption				
Motor Type	Low Cost Iron Core			
max. Current [mA]	630	330	630	330
Construction				
Pump Head	standard optional	PPS customer specific - upon request		
Diaphragm, Valves	standard optional	EPDM FKM / FFKM / PTFE		
Weight [g]	165		165	

Performance Curves

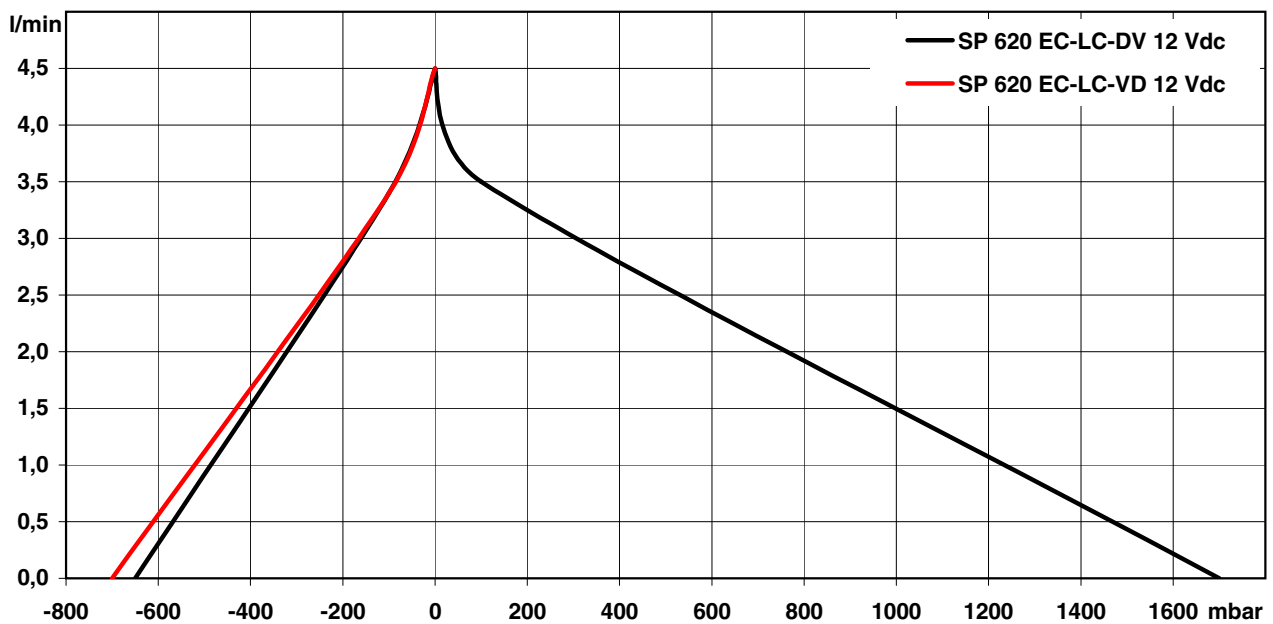



The pumps listed below represent a typical selection of our wide range of eccentric pumps and are intended for initial tests. Customised versions for your individual application would be made without extra costs - please contact us!

Designation	SP 620 EC-DV		SP 620 EC-VD	
Operating Voltage	12 Vdc	24 Vdc	12 Vdc	24 Vdc
Art.No.	7s57002	7s57003		
Pneumatic Performance				
Free Flow [l/min]	4,6	4,0	4,6	4,0
flow at:	Pressure Side			
100 mbar [l/min]	3,7	3,1	-	-
max. Pressure [mbar]	1800	1800	-	-
flow at:	Vacuum Side			
-100 mbar [l/min]	3,5	3,0	3,5	3,1
max. Vacuum [mbar]	-640	-640	-700	-700
	Higher performances on request			
Motor / Power Consumption				
Motor Type	Long Life Double Ball Bearing			
max. Current [mA]	550	290	550	290
Construction				
Pump Head	standard optional	PPS customer specific - upon request		
Diaphragm, Valves	standard optional	EPDM FKM / FFKM / PTFE		
Weight [g]	184		184	

Performance Curves

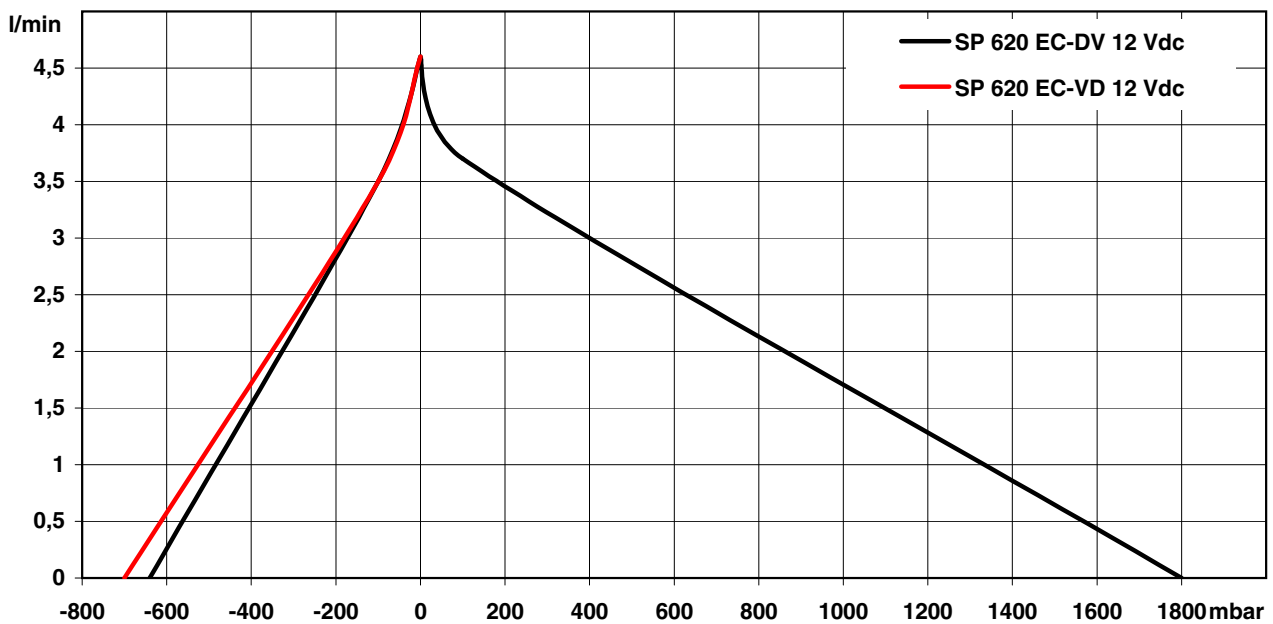



Eccentric Diaphragm Pumps for Gas / Air

SP 600 EC / 620 EC / 625 EC

The pumps listed below represent a typical selection of our wide range of eccentric pumps and are intended for initial tests. Customised versions for your individual application would be made without extra costs - please contact us!

Designation	SP 625 EC-LC-DV		SP 625 EC-LC-VD	
Operating Voltage	12 Vdc	24 Vdc	12 Vdc	24 Vdc
Art.No.	7s57276	7s57277	7s57278	7s57279
Pneumatic Performance				
Free Flow [l/min]	6,0	6,0	6,0	6,0
flow at: Pressure Side				
100 mbar [l/min]	5,0	5,0	-	-
max. Pressure [mbar]	1800	1800	-	-
flow at: Vacuum Side				
-100 mbar [l/min]	4,9	4,9	5,0	5,0
max. Vacuum [mbar]	-650	-650	-750	-750
Higher performances on request				
Motor / Power Consumption				
Motor Type	Low Cost Iron Core			
max. Current [mA]	900	500	900	500
Construction				
Pump Head	standard optional	PPS customer specific - upon request		
Diaphragm, Valves	standard optional	EPDM FKM / FFKM / PTFE		
Weight [g]	220		220	

Performance Curves

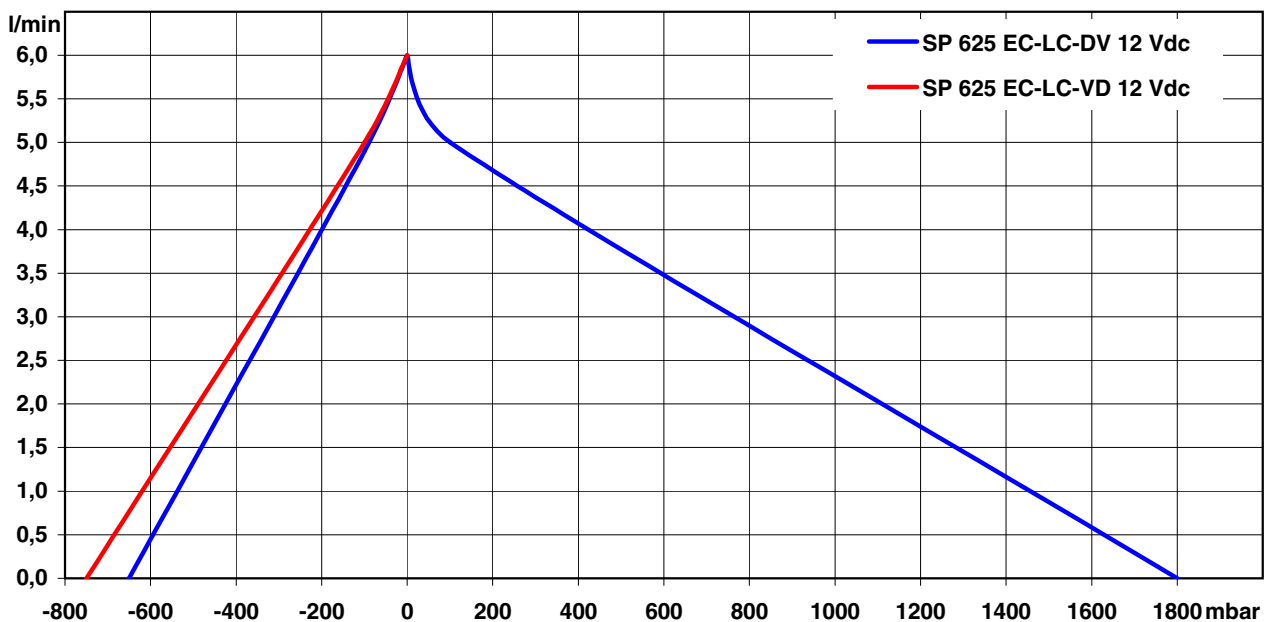



Eccentric Diaphragm Pumps for Gas / Air

SP 600 EC / 620 EC / 625 EC

SP 600 EC / 620 EC-DV / 620 EC-VD

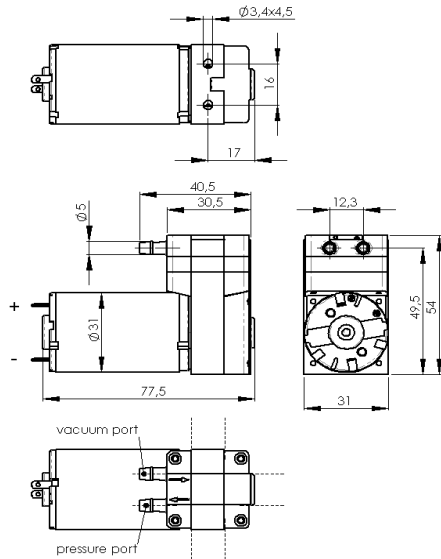

SP 600 EC-LC / 620 EC-LC-DV / 620 EC-LC-VD

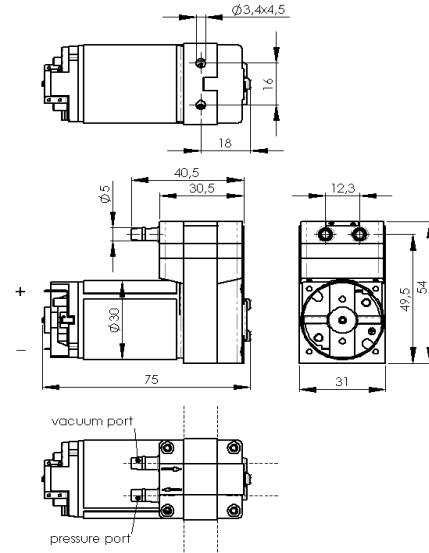

SP 625 EC-LC-DV / 625 EC-LC-VD

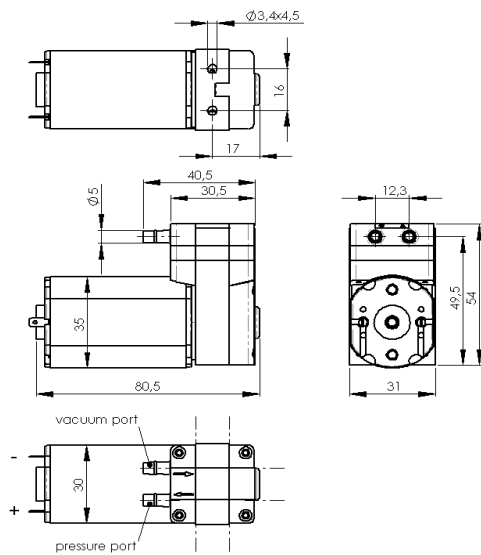

optional mounting plate

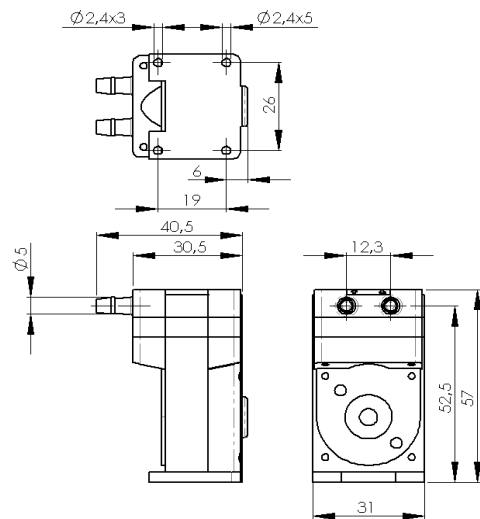

Standard: connection ports as shown. Optional: 3 other port positions possible (see dashed lines)